

# Overview and Characteristics of Fan

## Overview

A cooling fan is widely used to extend life of your system by cooling off heat of the system that many electrical components are mounted in a very high density and dissipating heat. Since we SANYO DENKI developed "San Ace" which is the first AC fan in Japan in 1965, we have increased fan motor lineup until now meeting customer's needs rapidly based on our tremendous career. We SANYO DENKI will continue to develop new fans with high airflow, low noise, low vibration, and energy-saving design.

## Characteristics

We can roughly divide fan into two types which are AC and DC.

### AC fans

SANYO DENKI succeeded in the mass-production of AC fans in 1965. SANYO DENKI was the first Japanese manufacturer to have succeeded at this.

- High performance
- High reliability
- Safety

### DC fans

SANYO DENKI succeeded in the mass-production of DC fans in 1982.

- High performance
- Low power consumption
- Low vibration
- Low leakage of flux
- High reliability

SANYO DENKI currently has a wider variety of products like Long Life Fan, CPU cooler, Splash Proof Fan, and Oil Proof Fan etc to meet all customer needs.

## Reliability and expected life

A cooling fan generally cools itself as well. The temperature rise of the motor is relatively low and the temperature rise of the grease in the bearings is also low, so expected life is longer than general some either motors. Since the service life of bearings is a theoretical value that applies when they are ideally lubricated, the life of lubricant can be regarded as expected life of the fan. DC fan consumes less power and its temperature rise of bearing is very low. When the measurement conditions are: L10 (the remaining product life in the lifespan test is 90%), with an ambient temperature of 60°C (85°C for Wide Temperature Range Fans), at the rated voltage, and continuously run in a free air state. The table below indicates the relationship between ambient temperature and expected life estimated on the basis of our life tests and same other tests conducted by SANYO DENKI.

### Expected life of DC fans

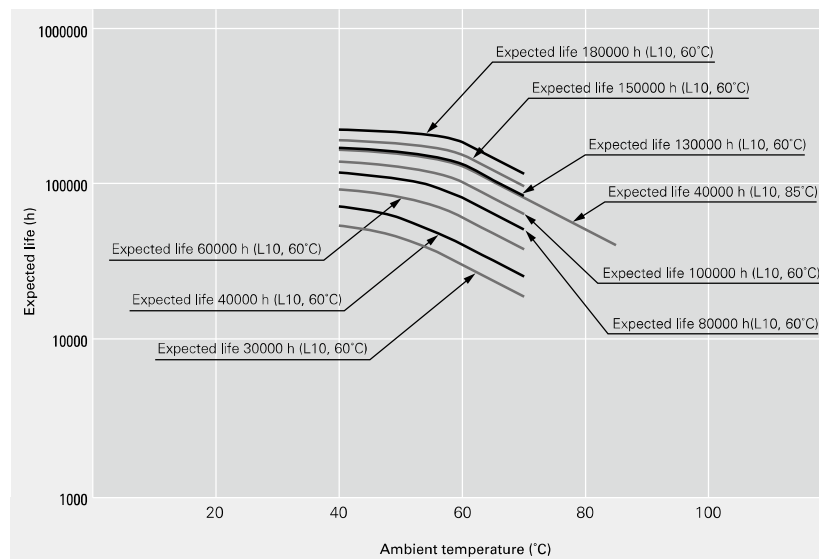

Rated voltage, continuously run in a free air state, survival rate of 90%

### Expected life of AC fans

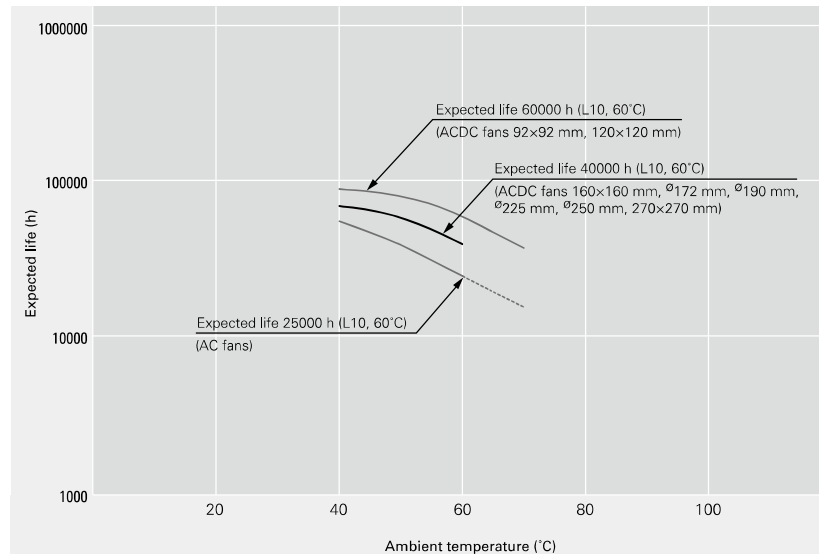

Rated voltage, continuously run in a free air state, survival rate of 90%

## Noise characteristics

Noise is average value that measured at 1 meter away from air intake side of fan that is suspended on special frame in anechoic chamber (as per JIS B 8346).

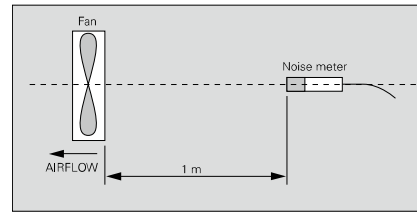

Acoustic radio wave anechoic chamber



Noise characteristic measurement equipment



## Measuring airflow and static pressure

It is very difficult to measure airflow and static pressure. In fact, the performance curve may vary greatly according to the type of measuring equipment.

The commonly-used type of measuring equipment is a wind tunnel using a Pitot tube. SANYO DENKI uses a very precise method using double chamber equipped with many nozzles.

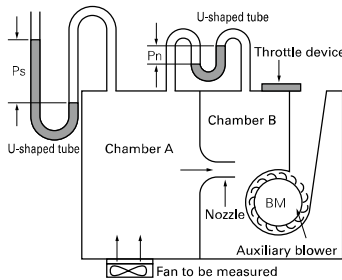

Double chamber measuring equipment

$$Q = 60A\bar{v} \text{ (A)}$$

where

$Q$  = airflow ( $\text{m}^3/\text{min}$ )

$A$  = cross sectional area of nozzle =  $\frac{\pi}{4}D^2$  ( $\text{m}^2$ )

$D$  = nozzle diameter

$\bar{v}$  = average airflow velocity of nozzle =  $\sqrt{2g\frac{P_n}{\gamma}}$  ( $\text{m/s}$ )

$\gamma$  = Specific weight of air =  $\rho g$  ( $\text{N/m}^3$ )

(Air density  $\rho = 1.2 \text{ kg/m}^3$  at  $20^\circ\text{C}$ , 1 atm)

$g$  = acceleration of gravity =  $9.8 \text{ (m/s}^2\text{)}$

$P_n$  = differential pressure (Pa)

$P_s$  = static pressure (Pa)

The measuring equipment using double chamber is method to be calculated from airflow goes through nozzle and differential pressure between pressure of inside of chamber ( $P_s$ ) and atmospheric pressure by measuring differential pressure between air intake and exhaust of nozzle ( $P_n$ ).

## Conversion table

### Static pressure

1 mm  $\text{H}_2\text{O}$  = 0.0394 inch  $\text{H}_2\text{O}$

1 mm  $\text{H}_2\text{O}$  = 9.8 Pa (Pascal)

1 inch  $\text{H}_2\text{O}$  = 25.4 mm  $\text{H}_2\text{O}$

1 Pa = 0.102 mm  $\text{H}_2\text{O}$

1 inch  $\text{H}_2\text{O}$  = 249 Pa

### Airflow

1  $\text{m}^3/\text{min}$  = 35.31  $\text{ft}^3/\text{min}$  (CFM)

1 CFM = 0.0283  $\text{m}^3/\text{min}$

1  $\text{m}^3/\text{min}$  = 16.67  $\ell/\text{s}$

1 CFM = 0.472  $\ell/\text{s}$

1  $\ell/\text{s}$  = 0.06  $\text{m}^3/\text{min}$

# Motor Protection

If the fan blades are restricted, an overcurrent occurs and leads to a rise in the fan coil temperature. This can result in reduced performance, damage, or a fire. To prevent this from occurring, SANYO DENKI's fans incorporate an overheating protection function.

## **Reverse polarity protection function (DC fan)**

No problem about fan even if positive & negative lead are connected in reverse.

However, when wiring fans with sensors or PWM speed control function, connecting positive and negative leads in reverse may damage the fans.

## **Burnout protection function at locked rotor condition (DC fan, ACDC fan)**

Current cutoff system

If the fan blades are restricted, the coil current is cut off at regular cycles to prevent overheating of the coil. When the hindrance is removed, the fan restarts automatically.

## **Burnout protection function at locked rotor condition (AC fan)**

Impedance protection (60 mm sq., 80 mm sq., 92 mm sq., 120 mm sq.)

This system is used for shading coil-type fans. When the blades are restricted, the current is reduced by the impedance of the coil itself to prevent a temperature rise in the coil. However, if the applied voltage exceeds the specification range, an overcurrent can occur and result in overheating, and so care needs to be taken.

Thermal protection (160 mm sq.,  $\varnothing$ 172 mm)

This system is used for condenser phase-type fans. A temperature sensor is incorporated in the coil so that if the temperature exceeds the specification temperature, the current is cut off to prevent overheating of the coil.

# Guideline in Selecting a Fan

## How to select an appropriate fan

The following example is a guideline regarding how to select an appropriate fan for cooling your system

### Determining of your system specifications and conditions

Determine the temperature rise inside your system and obtain the total heating value inside your system on the basis of its inputs and outputs.

Example

V: Total heating value of your system (W)=100 (W)

$\Delta T$ : Inside temperature rise (K)=15 (K)

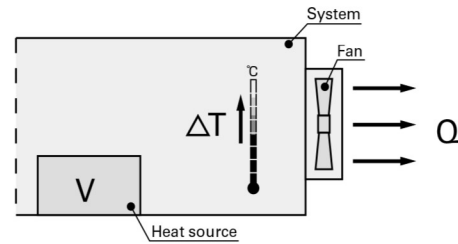

### Calculating the required airflow for cooling

After the equipment specifications and conditions of your system have been determined, calculate required airflow to meet the conditions. (Note that the formula shown below only applies when the heat radiation is performed only by cooling air from the fan.)

Example

$Q'$ : Motion airflow ( $m^3/min$ )

$$Q' = \frac{V}{20\Delta T} = \frac{100 (W)}{20 \times 15 (K)} \approx 0.33 (m^3/min)$$

### Selecting the fan

After the motion airflow has been calculated, select an appropriate fan motor based on the value. The motion airflow when the fan motor is actually mounted in your system can be obtained using the airflow-static pressure characteristics curve and system impedance. However, the system impedance cannot be measured without a measuring equipment, so fan with 1.5 to 2 times higher airflow than the actual max airflow should be selected (operating airflow is one-third to two-thirds of maximum airflow).

Example

Q: Maximum airflow ( $m^3/min$ )

$$Q' = Q \times 2/3$$

$$Q = Q' \times 3/2 = 0.33 \times 3/2 \approx 0.5 (m^3/min)$$

Next, In case that you select a fan having an airflow of 0.5 ( $m^3/min$ ) or more and a appropriate size for the space inside your system.

For example, If you need a fan of 60 mm square, 25 mm thickness and 12 V, you should select is 9RA0612H4001 (maximum airflow = 0.54  $m^3/min$ ).

### Confirming the selected fan

Calculate the temperature rise inside your system when your system having 100 (W) of total heating value is forcefully cooled down by a 9RA0612H4001 fan.

Example

$$Q' = Q \times 2/3 = 0.54 \times 2/3 \approx 0.36 (m^3/min)$$

$$\Delta T = V / 20Q' = 100 (W) / 20 \times 0.36 (m^3/min) \approx 13.9 (K)$$

From the above, the temperature rise inside your system is calculated as 13.9 (K).

Since the value obtained from the above equation is only a rough target, final fan selection should be based on your actual installation test.

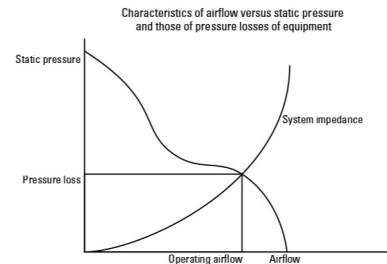

## Portable measuring device for measuring airflow and system impedance within equipment

### San Ace Airflow Tester

#### ■ Features

#### Enables the selection of the optimal fan for a device

An optimal fan for a device can be selected by entering accurate measurement results into thermal design simulation software.

#### Compact and lightweight

With a compact design and weight of approximately 6 kg, it is portable enough to measure immobile equipment.

Please refer to page 592 for detail.



With connection duct mounted

# Specifications for DC Fan Sensors

## Pulse sensor (Tach output type) example

Pulse sensor outputs two pulse waves per revolution of fan, and it is good to detect fan speed. Pulse sensors can be incorporated in all kinds of DC fans.

Noise from inside the fan or from external devices may effect sensor output.

Contact us for more information.

The specifications listed below are for the 9G1212H101 model, and vary with the model number used. Please contact your point of sale for details.

### Output circuit

Open collector

### Specifications

$V_{CE} = +30\text{ V max.}$

(For a 48 V-rated fan:  $V_{CE} = +60\text{ V max.}$ )

$I_c = 10\text{ mA max.}$  [ $V_{OL} = V_{CE}(\text{SAT}) = 0.4\text{ V or less}$ ]

Inside of DC fan

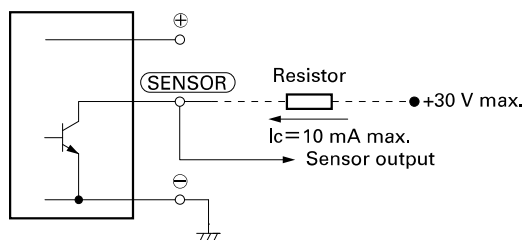

### Output waveform (Need pull-up resistor)

In case of steady running

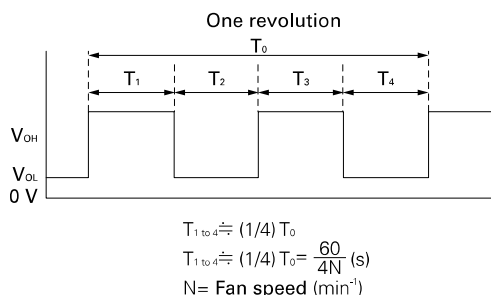

If you want detailed specifications that apply when the rotor is locked, please contact SANYO DENKI.

## Locked rotor sensor (rotation / lock detection type) example

Locked rotor sensor outputs fan status signals. It is good to check whether the fan is running or locked

Noise from inside the fan or from external devices may effect sensor output.

Regarding details of the reverse logic and specifications of lock sensor output signals, please contact SANYO DENKI.

Lock sensor can not be used in some models. Contact us for more information.

The specifications listed below are for the 9G1212H1D01 model, and vary with the model number used. Please contact your point of sale for details.

### Output circuit

Open collector

### Specifications

$V_{CE} = +27.6\text{ V max.}$

For a 48 V fan  $V_{CE} = +60\text{ V max.}$

$I_c = 5\text{ mA max.}$  [ $V_{OL} = V_{CE}(\text{SAT}) = 0.6\text{ V or less}$ ]

For a 48 V fan:  $V_{CE}(\text{SAT}) = 0.4\text{ V or less}$

Inside of DC fan

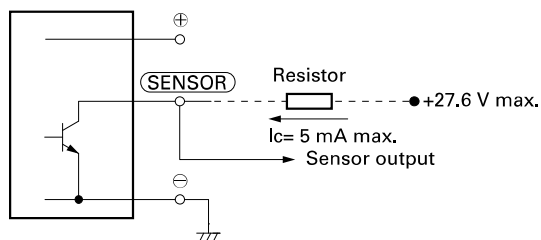

### Output waveform (Need pull-up resistor)

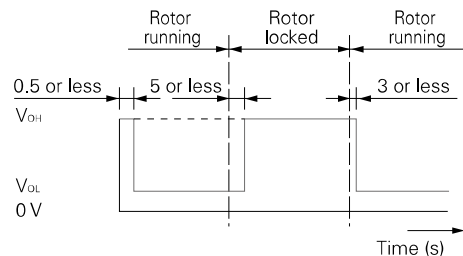

Note: The output is completely at  $V_{OL}$  with 0.5 s or less after power-up.

## Low-speed sensor (rotating speed detection type) example

Low-speed sensor outputs a signal when fan speed goes down to trip point or less. It is good to detect cooling degradation of fan. Noise from inside the fan or from external devices may effect sensor output, please. If you want detailed specification and reverse signal output, please contact SANYO DENKI. Low-speed sensors can not be used in some models. Contact us for more information.

The specifications listed below are for the 9G1212H1H01 model, and vary with the model number used. Please contact your point of sale for details.

### Output circuit

Open collector

### Specifications

$V_{CE} = +27.6 \text{ V max.}$

$I_C = 10 \text{ mA max.}$  [ $V_{OL} = V_{CE}(\text{SAT}) = 0.5 \text{ V or less}$ ]

Inside of DC fan

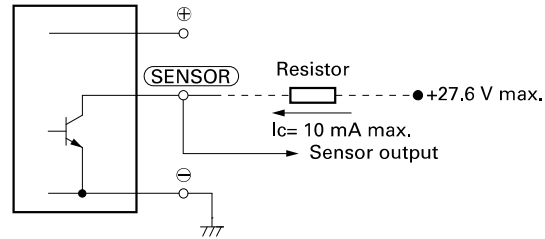

### Sensor scheme

Example 1: In case steady running

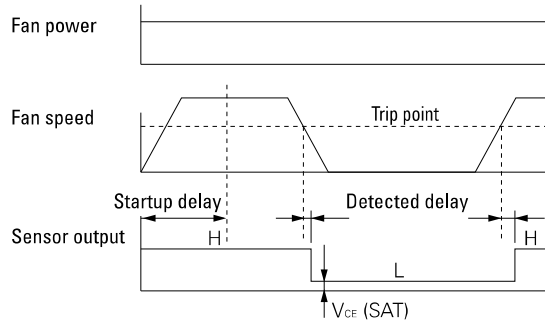

Example 2: In case that the rotor is locked when the fan motor is turned on and released after the start-up delay time

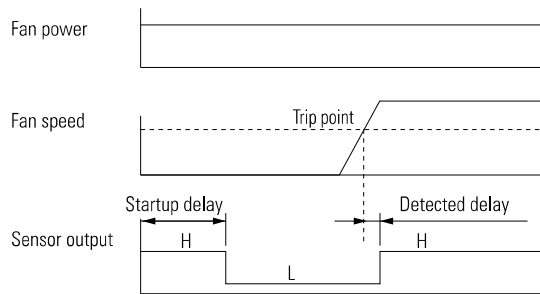

# Specifications for AC Fan Sensor

ACDC fan sensor specifications differ from those below. Please refer to each product page.

## Specifications of sensor circuit

	5 V (ITEM-20*)	12 V (ITEM-30*)
Example of model.no	109S405UL	
System	Speed detection, Auto-restart, Open collector	
Power supply	5 VDC±10% At 5 V, 6 mA	12 VDC±20% At 12 V, 10 mA
Recommend sensor circuit output	At Vp= 5 V, I= 100 mA max. At Vp= 12 V, I = 200 mA max.	
Trip point	Standard speed: 1700 min <sup>-1</sup> ±10% Low speed: 850 min <sup>-1</sup> ±10%	
Response speed	Standard speed: Startup delay 18 s Detection delay 1 s Low speed: Startup delay 36 s Detection delay 2 s	
Insulation resistance	10 MΩ min. at 500 VDC (Note)	
Dielectric strength	50/60 Hz, 1000 VAC, 1 minute (Note)	
Ambient conditions	Temperature: -10 to +70°C , humidity: 90% RH max. (at 40°C)	



\*[ITEM-20] and [ITEM-30] are printed on the fan nameplate.

Note: Between one end that all sensor leads consisting of brown, yellow and black are tied together and the G terminal or power terminal of the fan.

## Sensor scheme

Example 1: When the AC power for the fan and the DC power for the sensor are turned on at the same time

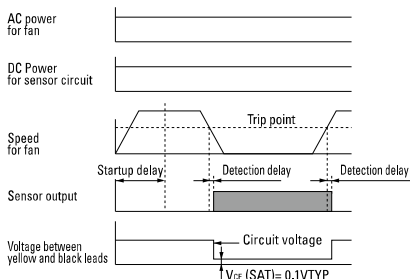

Example 2: When the AC power for the fan is turned on first, then the DC power for sensor is powered on

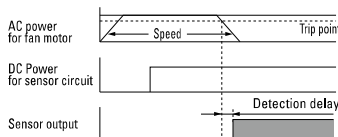

Example 3: When the DC power for sensor is first powered on, then the AC power for the fan is turned on

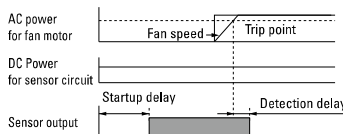

## Sensor output circuit

5 V (ITEM-20\*)

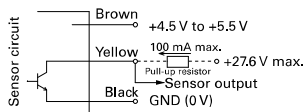

12 V (ITEM-30\*)

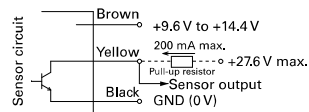

GND (Black) should be shared in case that power supply for sensor circuit (Brown) and that for sensor pull-up (Yellow) are separated.

# Fans with PWM Control

## PWM control

### 1. Overview

Pulse Width Modulation (PWM) control enables you to externally control the speed of the fan by varying the duty cycles of PWM input signals between control and grounding terminals. It allows fans to operate optimally in response to the device's heat level, lowering the noise and power consumption of the system.

PWM control has the following advantages:

- (1) Because the PWM signal is digitally input, precise control is possible.
- (2) Because the PWM signal is digitally input, multiple fans can be controlled.
- (3) Upon users request, how the fan speed responds to PWM signals can be customized. For example, fan can be set to stop or run at low speed at 0% PWM duty cycle.

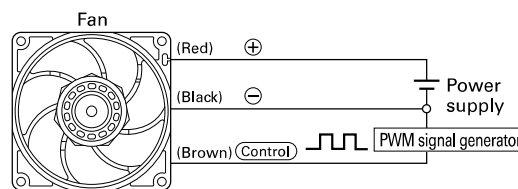

### 2. PWM duty input signals and wiring diagram

Other than a voltage input, an open collector/drain input can be used for PWM signal input.

Be noted that if an open collector/drain input is used or applied an input voltage and frequency is out of specified range, how the fan speed responds to the PWM duty cycle may be altered.

The input signal voltage and the frequency differ with models. Please contact us for details.

#### Example of input signal

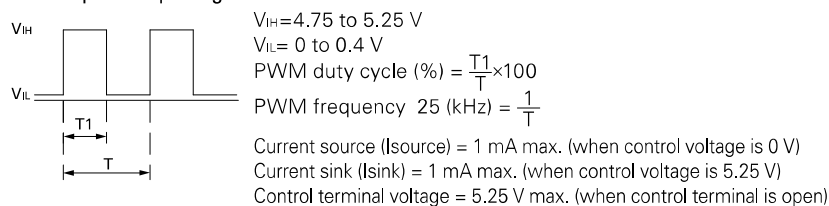

#### Wiring example

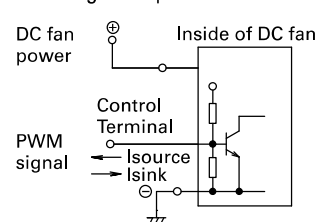

### 3. PWM duty cycle – Speed characteristics

Fan speed of PWM control fans change, as the below performance curve shows, in response to the PWM duty cycle input.

If necessary, users can do the speed setting by themselves, making the fans operate at the optimum speed.

Also, upon user's request, how fan speed responds to a PWM signal can be customized so that the fan stops or runs at low speed for a certain PWM duty cycle input. The below performance curve is for a fan that stops at 0% PWM duty cycle. Specifications differ with models. Please contact us for details.

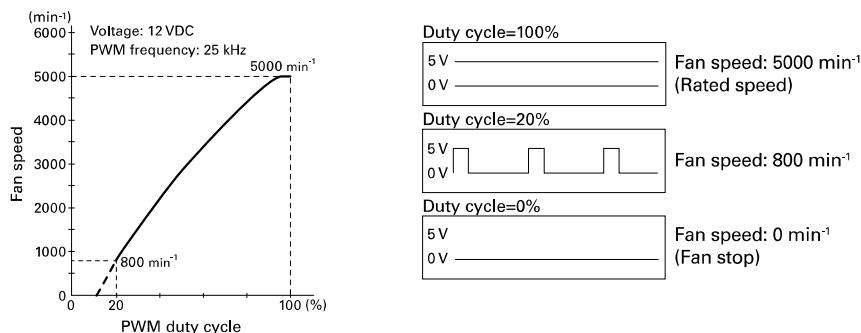

The dotted part of the performance curve (area below 20% PWM duty cycle in the above case) indicates the fan speed is unstable in the area.

### 4. When you wish to obtain a fan performance with 100 or 0% PWM duty cycle without a PWM signal generator for built-in test.

Performance at 100% PWM duty cycle: Leave the control lead wire open and no connection.\*

Performance at 0% PWM duty cycle: Connect the control lead wire directly to ⊖ pin.

\*Exception: San Ace 172AD... When control terminal is open, speed is the same as at 0% duty cycle.



## 5. Application examples of PWM control fan

Here are a few application examples of PWM control fan.

(1) This system controls the fan speed in response to changing device temperature.

By combining a PWM control circuit and thermistor that detects temperature of device and its parts, it is able to control the fan speed of PWM control fan in response to the changing temperature.

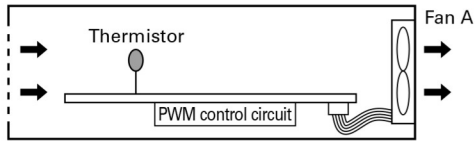

(2) Simultaneous control of multiple fans

Because PWM control is done with digital signal inputs, regardless of fan types or input voltage, multiple fans can be controlled simultaneously.

Below figure shows a system that can control multiple fans with various PWM characteristics simultaneously. Such systems contribute to the low power consumption and noise.

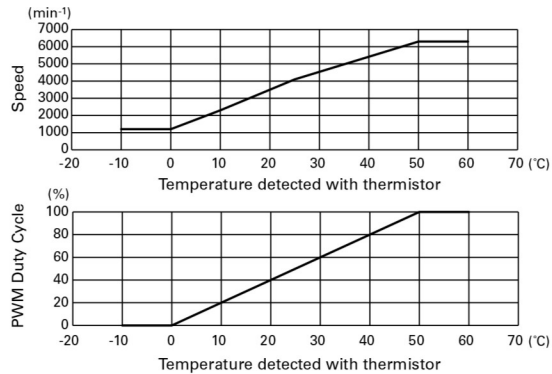
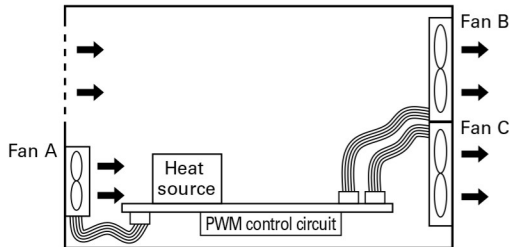

Operation mode	PWM Duty	Fan A	Fan B, C
Full-power	100%	5000 min <sup>-1</sup>	5000 min <sup>-1</sup>
Normal	60%	3500 min <sup>-1</sup>	4000 min <sup>-1</sup>
Standby (eco mode)	0%	Stop	1500 min <sup>-1</sup>

Fan A  
(model that stops at 0% PWM duty cycle)

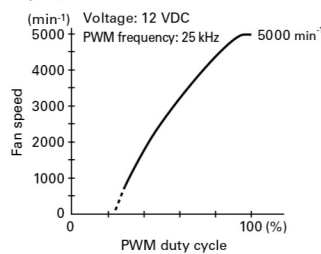

Fan B, C  
(model that runs at low speed at 0% PWM duty cycle)

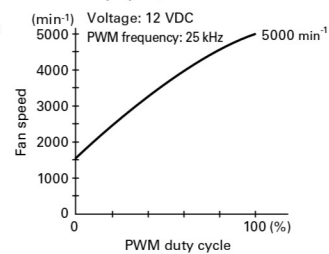

### Controlling device that easily regulates the rotational speed of PWM control fans

#### San Ace PWM Controller

##### ■ Features

##### Reduces system power consumption and fan noise

For PWM fan speed control, a PWM control circuit needs to be newly designed and configured.

By using this product, however, PWM fans can be fully utilized without the need for preparing new circuits, contributing to reducing the system power consumption and the fan noise.

##### Can be common-powered by the fan power supply

The controller can be powered by the fan power supply of rated voltage 12, 24, and 48 VDC, and no separate supply is required.

##### Maximum of four fans connectable

Up to four PWM fans can be connected and controlled.

Please refer to page 588 for detail.

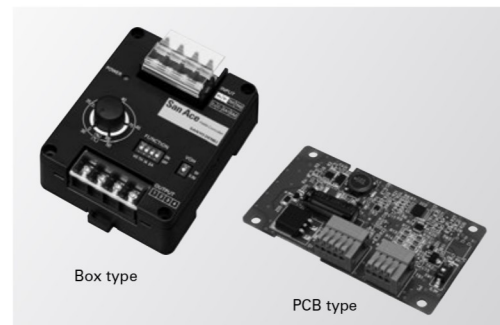

Box type

PCB type

# Splash Proof Fan

## Ingress protection ratings (IP code)

The degree of protection of our products are rated as per IEC (International Electrotechnical Commission) 60529. The protection ratings of our fans only apply to electrical components (motor coils and electronic components) and do not cover mechanical components (blades, frames, and bearings). Please test fans in your environment before purchase as they may not operate properly with water or dust depending on the operating environment.



Protected electrical components and motor coils

### ■ Definition of Ingress Protection (IP Code)

**I P X X**

Second digit: Protection against water  
 First digit: Protection against solid objects and access to hazardous parts

First digit	Definition
0	No protection
1	Protection against solid objects > 50 mm
2	Protection against solid objects > 12.5 mm
3	Protection against solid objects > 2.5 mm
4	Protection against solid objects > 1 mm
5	Protection against a level of dust that could hinder operation or impair safety
6	Complete protection against dust

Second digit	Definition
0	No protection
1	Protection against dripping water
2	Protection against water spray up to 15°
3	Protection against spraying water
4	Protection against splashing water
5	Protection against low pressure water jets
6	Protection against high pressure water jets
7	Protection against temporary immersion in water
8	Protection against submersion in water

### ■ IPX8 Requirements

When the power is off, the fan is submerged in water pressurized to the equivalent of 2 meters for 60 minutes. Then it's run for 15 minutes at the rated voltage in free-air. During the test, there shall be no reduction in dielectric strength or fan characteristics.

**UPS, inverter, rectifier, high-voltage power supply, etc.**

**Cautions for Use of a Cooling Fan in the Vicinity of a Power Switching Circuit** (prevention of electrolytic corrosion)

If a fan is installed near a large-power or high-voltage switching circuit, the heavy electromagnetic noise resulting from electromagnetic induction in such circuits or the influence of high-frequency noise imposed through the power line of the fan may induce current through the shaft bearing of the fan. Such current may damage the oil film on the bearing and even the friction surface of the bearing. This adverse effect is known as "electrolytic corrosion of the fan." Electrolytic corrosion affects the smooth revolution of the fan and may reduce its service life. An audible symptom is unusual noise emitted from the fan. This adverse effect is often observed and may partly be explained by the practice of mounting high-density parts, which reduces the gap between the switching circuits and the fan and the use of higher switching frequencies apt to provoke induction. Data processing/communications devices that operate at low voltages are not liable to electrolytic corrosion since they generate less electromagnetic noise.

**A Case of electrolytic corrosion**

Fans without anti-corrosion features installed near components that generate electromagnetic noise, such as inverter controllers, are liable to experience electrolytic corrosion.

No.	Use	Period until the occurrence of unusual noise
1	Switching power supply	6 months to 2 years
2	UPS	6 months to 2 years
3	General-purpose inverter	1 to 1.5 years
4	Air cleaner	2 to 3 months
5	Inverter for LCDs	6 months

The curve shown in the graph below represents the relationship between the level of the electromagnetic noise induced by a fan and the distance from the fan to the noise source.

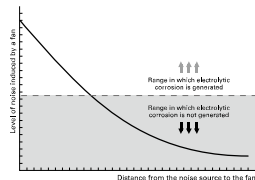

**Occurrence of electrolytic corrosion Pattern 1**

1. The fan gets charged with high-frequency electricity by high-frequency noise (electric field/magnetic field) generated in the switching circuit.
2. Because of high-frequency electricity charged in the fan, an electric current flows through the bearing of the fan.
3. The electric current breaks the oil membrane on the surface of the bearing and the bearing gets abraded (electrolytically corroded).
4. This symptom often occurs in equipment in which switching circuits are sped up and implemented in high density.
5. Countermeasure 1: To provide a shield plate<sup>(1)</sup> inside the fan (The plate should be such that does not interfere with airflow).
6. Countermeasure 2: To use a fan with ceramic bearings.

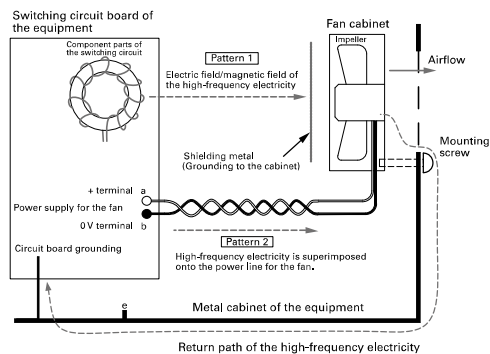

**Occurrence of electrolytic corrosion Pattern 2**

1. High-frequency electricity flows from the circuit board into the inside of the fan superimposed with the power line for the fan.
2. High-frequency electricity that has entered into the fan flows through the bearing.
3. Oil membrane on the surface of the bearing gets broken and the bearing gets abraded (electrolytically corroded).
4. Countermeasure 1: To remove high-frequency component between terminals "a" and "b", "a" and "e" and "b" and "e" of the power supply for the fan, or to insert a filter<sup>(2)</sup> into the power line for the fan.
5. Countermeasure 2: To use a fan with ceramic bearings
6. Cables should be twisted in order to decrease induction to the power line for the fan.

(1) Shielding metal plate  
As an electromagnetic shield metal, "EMC Guard" is available from our company. Certain shielding effect can be expected from mounting a general-purpose finger guard inside the fan. In each case, grounding to the cabinet is required.

(2) Filter  
Insert a common mode filter when the high-frequency electricity is superimposed on both lines "a" and "b" in the same phase and, if not, insert a normal mode filter.

## Measures against electrolytic corrosion

- Relocate fans far from all electromagnetic noise sources.
- Attach an EMC guard to ordinary fans. This should have an effect on electromagnetic noise due to radiation.
- As a power supply, the fan is wired from a circuit for which noise is not superimposed.
- Against heavy electromagnetic noise (electromagnetic induction) and conductive noise from the power supply line for a fan, we recommend the use of an "Electrolytic corrosion proof fan" with ceramic bearing.

This cooling fan prevents electrolytic corrosion of bearings even under conditions where electromagnetic noise is generated. Electrolytic corrosion of ball bearings is prevented by using ceramic balls in ball bearings. The ceramic material is an insulating material.

### Component diagram

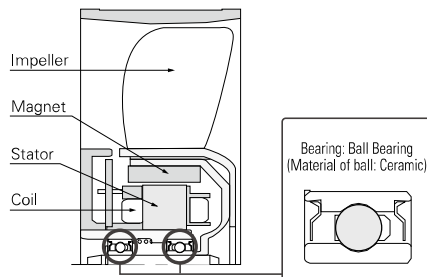

### Caution

Electrolytic Corrosion Proof Fan has been designed to prevent the electrolytic corrosion of ball bearings in the fan, but this does not guarantee that the fan will operate normally under conditions where there is strong electromagnetic noise.

Please be sure to fully evaluate the value of fan malfunction due to noise in advance.

# Safety Standards

Our products conform to these directives and safety standards. For compliance with standards, see individual product pages. Safety standard registration numbers are as follows.

Standard name	UL	CSA	TÜV
Certification number	E46810	172248	Varies by model

## 1. UL ratings (USA)



Underwriters Laboratories Inc. was established by the American Union of Fire Insurance Underwriters. The purpose of UL is to ensure safety of machines, equipment, and materials and protect human lives and property from fire and other accidents. To that end, UL has conducted numerous tests and extensive research and, as a result, set up UL ratings. Any seller of products in any of the majority of the states of the USA must produce their products according to the UL ratings, have them pass UL-specified safety inspections, and have them listed in UL's registration book. Therefore, to export and sell any product in the United States, one must in most cases apply for UL-listing.

Additionally, UL is accredited by The Standards Council of Canada (SCC) as both a Certification Organization (CO) and a Testing Organization (TO) and is officially recognized in all provinces and territories throughout Canada. Accordingly, our products can be tested by UL for compliance with Canadian safety standards. Certified products are entitled to display the cUL Mark, which authorizes their use and sale in Canada. If products are deemed to be compliant with both U.S. and Canadian standards, then both the UL Mark and cUL Mark can be displayed or a combination U.S. and Canadian mark (bottom left).

Our fans are certified as satisfying all UL 507 requirements.

## 2. CSA standards (Canada)



The Canadian Standards Association (CSA) was set up in response to the advice of the Canadian government. In Canada, the law prohibits the use and sale of any product other than those approved under CSA in terms of safety. CSA has set up CSA standards as inspection procedures and other requirements to ensure product safety.

Our products are certified as satisfying the CSA standard C22.2 No. 113.

## 3. EN standards (EU members)



In the EU territory, the harmonization of industrial standards and safety standards of different countries is under way. The unified standards are called Harmonized Standards. Each of these standards is marked EN above the standard number. EN standards offer the grounds in design and manufacture when one exports a product to the EU territory. In order for a product to receive a safety marking, the product must be found to conform to TÜV, VDE, or other relevant standard.

Our products are certified by TÜV Rheinland to meet the requirements of EN 60950-1/EN 62368-1. (San Ace Controller complies with EN 60730-1)

## 4. Electrical Appliances and Materials Safety Act (Japan)



As of April 1, 2001, the Electrical Appliance and Material Control Law has been revised and reenacted as the Electrical Appliances and Materials Safety Act (Japan).

AC fans are classified as 'Blowers' under 'Electric motor-operated appliances'. They are categorized as electrical products other than specific electrical appliances (with the exception of some models) and are required to be labeled to indicate PSE certification.

## 5. CE marking



To distribute goods in the EU territory, manufacturers are obligated to affix the CE marking to their products as a sign of conformity with EC directives. Manufacturers ensure that their products meet the requirements of individual directives by conforming to EN standards, or IEC standards if there is no applicable EN standards.

## 6. UKCA marking



It is required to affix the UKCA marking to products sold within the Great Britain market (England, Wales, and Scotland) of the United Kingdom as a sign of conformity to the UK regulations that correspond to EU directives.

## 7. Technical Standard Conformity Certification



The Technical Standard Conformity Certification mark, set by Japanese Ministry of Internal Affairs and Communications, indicates that the product is certified as either or both of the following: specific radio equipment defined in the Radio Act and terminal equipment defined in the Telecommunications Business Act. Our San Ace Controller has built-in Technical Standard Conformity-certified specific radio equipment defined in the Radio Act in Japan. It is also a certified terminal equipment based on the Telecommunications Business Act in Japan.

## 8. VCCI



VCCI is a membership organization in Japan that aims to suppress electromagnetic interference generated from information technology equipment by industry self-regulation. It sets standards for noise, which affects other communications equipment, generated from data-processing equipment. VCCI categorizes information technology equipment in two classes: Class A equipment is used in commercial and industrial areas and Class B equipment is used in residential and adjacent areas. Our San Ace Controller is categorized as Class B information technology equipment.

## 9. FCC



Federal Communications Commission (FCC) is an independent U.S. government agency responsible for implementing and enforcing U.S. communications law and regulations. Obtaining an FCC certification is required to sell communications equipment including radio equipment in the U.S. Our San Ace Controller complies with FCC Part 15 Class B.

# RoHS Directive Compliance

All products listed in this catalog conform to the RoHS Directive (2011/65/EU).

These Directives restrict the following ten hazardous substances: cadmium, lead, mercury, hexavalent chromium, PBB, PBDE, DEHP, BBP, DBP, and DIBP. Implementation schedule is as follows:

Products	Implementation date
Fans, PWM Controller, San Ace Controller	From January 2019 production onwards
Plug cords	From October 2018 shipment onwards
Finger guards, filter kits	From January 2018 shipment onwards
Airflow Tester	From July 2019 production onwards

# Operating Precautions Fan

## Temperature conditions

**Operating temperature:** Refer to the specifications table for each model.

**Storage temperature:** -20 to +70°C / -30 to +70°C (Varies for each model / Non-condensing)

Rapid change in temperature may cause condensation. Prevent condensation when storing. Condensation may affect lubrication performance and insulation.

## Power specifications

For the specification of rated voltage and voltage range, please check the catalog or drawing for the model number.

Use of voltage exceeding the specified range may lead to performance degradation, device failure, or fire hazards. Do not apply voltage that exceeds specifications to the fan.

An electronic circuit is used for the DC fan. For power supply, use power with ripple less than 5% with low line noise and surge to prevent electronic circuit trouble.

## Handling precautions

The fan motor is equipped with a precision ball bearing. Therefore, please handle the motors carefully in order not to shock the bearings.

## Installation tips

There are no limitations on the installation direction of fans or blowers. Fans have symbols on the fan indicating the airflow direction and blade rotation direction. When installing, use these symbols to check the airflow direction.

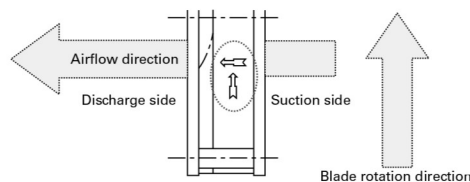

Symbols indicating the fan airflow direction and blade rotation direction

## Recommended screw torque

This shows the recommended values for the screw torque when installing the fans. If the tightening torque is higher than the recommended values, the fan can be deformed or damaged.

Use care when tightening. Also, be sure to always use a fan with a ribbed structure when securing by screws with both flanges.

### DC fan

Fan mounting hole diameter [mm]	Nominal screw diameter	Recommended screw torque
ø3.5, ø3.7	M3	0.44 N·m max.
ø4.3, ø4.5	M4	0.78 N·m max.
ø4.3, ø4.5	M4	0.98 N·m max. (ø172 mm×51 mm, ø172 mm×150 mm×51 mm, ø200×70 mm)

### AC fan

Fan mounting hole diameter [mm]	Nominal screw diameter	Recommended screw torque
ø3.5, ø3.7	M3	0.44 N·m max.
ø4.3	M4	0.58 N·m max. (120 mm×120 mm max.)
ø4.3	M4	0.78 N·m max. (ACDC fan, ø172 mm)
ø5.5	M4, M5	0.78 N·m max. (160 mm×160 mm)

## Comparison of ribbed and ribless structures

Regarding plastic frame, we have a option ribbed and ribless about mounting. Please use preferred type up to your application. Please use ribbed fan in case that you hook fan up clamping either side fan mounting hole target. (According to the model, only models with or without ribs are available.)

\*Use a fan with a rib structure when securing by screws with both flanges.

When securing screws to ribless plastic frame models, use a flange to secure on one side.

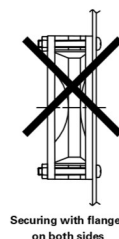
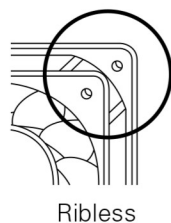
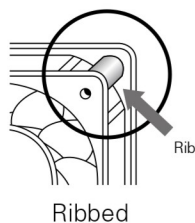

Securing with flanges on both sides

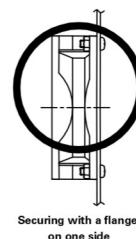

Securing with a flange on one side

# Fan Mounting Using Self-tapping Screw

Installing self-tapping screws into the plastic frame of the fan may split or deform it.

If using self-tapping screws, use screws that are recommended by our company, and refer to our recommended tightening torques and recommended pilot hole shapes. Pay close attention to the operating precautions and fully understand your equipment before you use it.

## Recommended screw torques

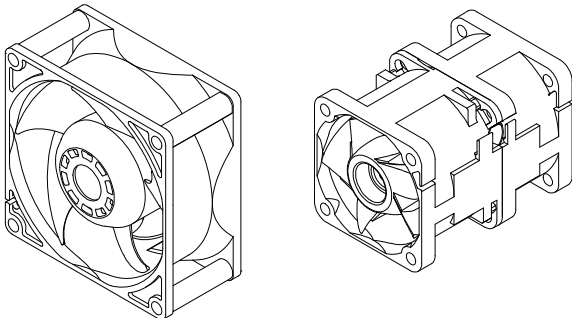

Fig. A: Ribbed fan

Fig. B: Counter rotating fan

	Recommended screw torque [N·m]	Fan mounting hole diameter [mm]
Ribbed fan (Fig. A)	0.8 max.	ø3.5. ø4.3. ø4.5
Counter rotating fan (Fig. B)	0.6 max.	

## Do not use self-tapping screws in the following cases:

- For ribless fans (except for counter rotating fans)
- When mounting finger guards on fans

Using self-tapping screws could deform or split the frame. Please use regular screws.

## Recommended pilot hole shape

[For nominal diameter 4 mm]

Self-tapping screw model no.  
SY-NS020412P11

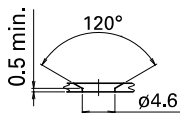

Self-tapping screw model no.  
SY-NS010412P11

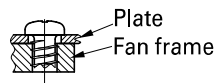
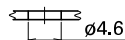

Minimum mounting plate thickness: T=1.2 mm

[For nominal diameters of 4.8 mm and 5 mm]

Self-tapping screw model no.  
SY-NS024812P15  
SY-NS020512P15

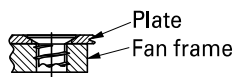
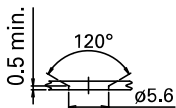

Self-tapping screw model no.  
SY-NS014812P15  
SY-NS010512P15

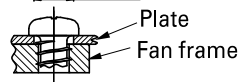
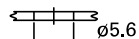

Minimum mounting plate thickness: T=1.2 mm

## Recommended self-tapping screws

· Material: Steel

· Plating: Trivalent chromating plating

unit: mm

Fan mounting hole diameter	Self-tapping screw model no.	Nominal screw diameter	Length [L]	Head shape	Flat-head/pan-head dimensions		
					Head diameter [D]	Height of head [H]	Cross recess No.
ø3.5	SY-NS020412P11	4	12	Flat	6.2	1.1 max.	2
	SY-NS010412P11	4	12	Pan	5.5	2.0	2
ø4.3	SY-NS024812P15	4.8	12	Flat	6.8	1.2 max.	2
	SY-NS014812P15	4.8	12	Pan	7.0	2.6	2
ø4.5	SY-NS020512P15	5	12	Flat	6.8	1.2 max.	2
	SY-NS010512P15	5	12	Pan	7.0	2.6	2

Head shape: Flat

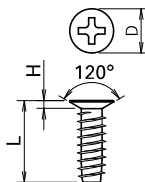

Head shape: Pan

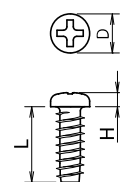

## Operating precautions

- Place the self-tapping screw so that it is vertical and centered with the frame mounting hole (Fig. A) and then screw it in. The self-tapping screw could deform or split the frame if you screw it into the frame when the screw is not vertical.
- Screw in the self-tapping screw with the center of the mounting hole on the fan and the center of the pilot hole on the mounting plate aligned (Fig. B). Misaligned holes could lead to the frame being deformed or split.

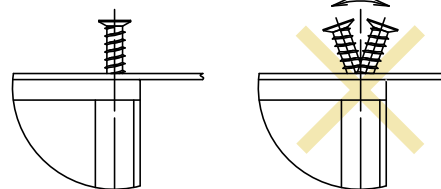

Vertically placed screw

Inclined screw

Fig. A

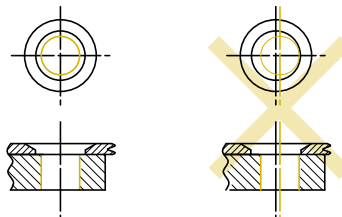

Aligned and centered holes

Misaligned holes

Fig. B

- Tightening the screw beyond the recommended screw torque could deform or split the frame.
- With flat-head screws, failure to use the recommended pilot hole shape will cause interference between the flat-head screw and fan frame which could split the frame.

## Recommended screw manufacturer

To purchase the screws, please contact the screw manufacturer directly.

SAIMA CORPORATION

2-9-17 Tsujido Fujisawa Kanagawa 251-0047 JAPAN

TEL:+81-466-36-3656 FAX:+81-466-36-0009

<https://www.saima.co.jp/en/top.php>

Please Read: